

# USER'S OPERATING MANUAL FOR PID DIGITAL TEMPERATURE CONTROLLER (Models: AI 7483 / 7883 / 7783 / 7983 / 7683)



## SPECIFICATIONS : -

### 1. DISPLAY TYPE

: Dual 4- Digit 7 Segment LED  
4 Digit Bright White (PV)  
4 Digit Luminous Green (SV)

Model no.	AI-7483	AI-7783	AI-7983	AI-7683	AI-7883
Display height (PV)	0.36"	0.56"	0.80"	0.36"	0.36"
Display height (SV)	0.24"	0.39"	0.56"	0.36"	0.36"

### STATUS LED'S

: OP 1, 1 : Main Control Output  
OP 2, 2 : Alarm 1 Status  
OP 3, 3 : Alarm 2 Status  
S : Soak Timer  
T : Tuning Status  
D : Digital Input

### 2. INPUT

Sensor input : TC:J,K,R,S,N,T,B & RTD: Pt-100  
Range : Refer below table.

Sensor Type	Range	Resolution	Accuracy
Fe-k(J) T/C	0 ~ 760°C	1 °C	± 1 °C
Cr-AL(K) T/C	-99 ~ 1300°C	1 °C	
(R) T/C	0 ~ 1700°C	1 °C	
(S) T/C	0 ~ 1700°C	1 °C	
TC - N	-99 ~ 1300°C	1 °C	
TC - T	-99 ~ 400°C	1 °C	
TC - B	0 ~ 1800°C	1 °C	
Pt-100(RTD)	-100 ~ 450°C	1 °C	
Pt-100(RTD 0.1)	-99.9 ~ 450.0°C	0.1 °C	± 0.3 °C

Sampling Time : 125 msec.  
Resolution : 1°C/0.1°C(Only for RTD)  
CJC for TC : Built in automatic  
LWC for Pt-100 : Built in upto 18E max.  
Digital Filter : 1 to 10 Sec.

### 3. RELAY OUTPUT

Contact type : N/O, CM, N/C  
Contact Rating : 5A @ 250VAC or 30 VDC  
Life expectancy : > 5,00,000 operations  
Isolation : Inherent

### 4. SSR DRIVE OUTPUT

Drive Capacity : 12V @ 30mA.  
Isolation : Non-Isolated.

### 5. FUNCTION

Output 1 : Main Control output  
Output 2 : Programmable  
1) Auxiliary control  
2) Alarm  
3) Soak timer  
4) Alarm + Soak timer  
Control Action : ON-OFF/PID (Select)  
Control Mode : Heat/Cool (Select)

### 6. ENVIRONMENTAL

Operating Range : 0 ~50°C, 5~90% Rh  
Storage Humidity : 95% Rh (Non-condensing)

### 7. POWER SUPPLY

Supply Voltage : 90~270VAC, 50/60Hz.  
Consumption : 4W Maximum.

### 8. PHYSICAL

Housing : ABS Plastic

## SAFETY INSTRUCTION :

This controller is meant for temperature control applications. It is important to read the manual prior to installing or commissioning of controller. All safety related instruction appearing in this manual must be followed to ensure safety of the operating personnel as well as the instrument.

## GENERAL

- ❖ The controller must be configured correctly for intended operation. Incorrect configuration could result in damage to the equipment or the process under control or it may lead personnel injury.
- ❖ The controller is generally part of control panel and in such a case the terminals should not remain accessible to the user after installation.

## MECHANICAL

- ❖ The Controller in its installed state must not come in close proximity to any corrosive/combustible gases, caustic vapours, oils, steam or any other process by-products.
- ❖ The Controller in its installed state should not be exposed to carbon dust, salt air, direct sunlight or radiant heat.
- ❖ Ambient temperature and relative humidity surrounding the controller must not exceed the maximum specified limit for proper operation of the controller.
- ❖ The controller in its installed state must be protected against excessive electrostatic or electromagnetic interferences. Ventilation holes provided on the chassis of the instrument are meant for thermal dissipation hence should not be obstructed in the panel.

## ELECTRICAL

- ❖ The controller must be wired as per wiring diagram & it must comply with local electrical regulation.
- ❖ Care must be taken not to connect AC supplies to low voltage sensor input.
- ❖ Circuit breaker or mains s/w with fuse (275V/1A) must be installed between power supply and supply terminals to protect the controller from any possible damage due to high voltage surges of extended duration.
- ❖ Circuit breaker and appropriate fuses must be used for driving high voltage loads to protect the controller from any possible damage due to short circuit on loads.
- ❖ To minimize pickup of electrical noise, the wiring for low voltage DC and sensor input must be routed away from high current power cables. Where it is impractical to do this, use shielded ground at both ends.
- ❖ The controller should not be wired to a 3-Phase supply with unearthed star connection. Under fault condition such supply could rise above 264 VAC which will damage the controller.
- ❖ The Electrical noise generated by switching inductive loads might create momentary Fluctuation in display, alarm latch up, data loss or permanent damage to the instrument. To reduce this use snubber circuit across the load.
- ❖ It is essential to install a over Temp. Protection device to avoid any failure of heating system. Apart from spoiling the product, this could damage the process being controlled.

**⚠ CAUTION:** To prevent the risk of electrical shock, switch off the power before making/removing any connection or removing the controller from its enclosure.

## MECHANICAL INSTALLATION

The label on the controller identifies the serial number, wiring connections and batch number.

### OVER ALL DIMENSIONS & PANEL CUT OUT (IN MM)

MODEL:-AI-7483/7783/7983

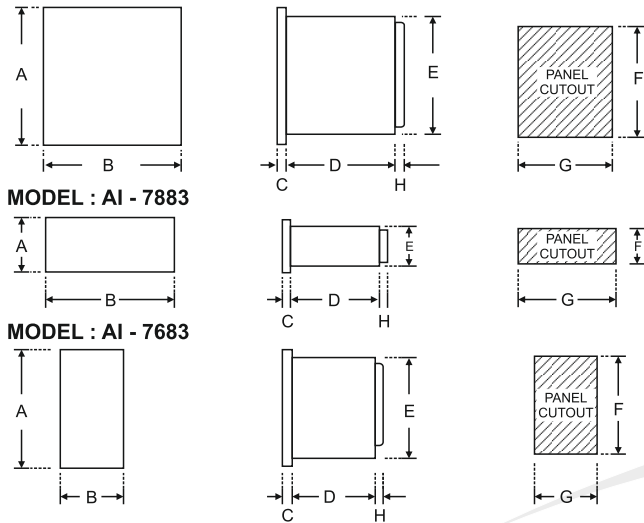

TABLE : 1

Dim Model	A	B	C	D	E	F	G	H
AI-7483	48	48	8	75	43	44	44	9
AI-7783	72	72	10	65	66	68	68	9
AI-7983	96	96	10	45	89	92	92	9
AI-7683	96	48	10	45	89	92	44	9
AI-7883	48	96	10	45	43	44	92	9

### INSTALLATION GUIDELINES :

1. Prepare the cut-out with proper dimension as shown in figure.
2. Remove clamp from controller
3. Push the controller through panel cut-out and secure the controller in its place by tightening the side clamp.

## ELECTRICAL INSTALLATION

The electrical connection diagram is shown on the controller enclosure as below.

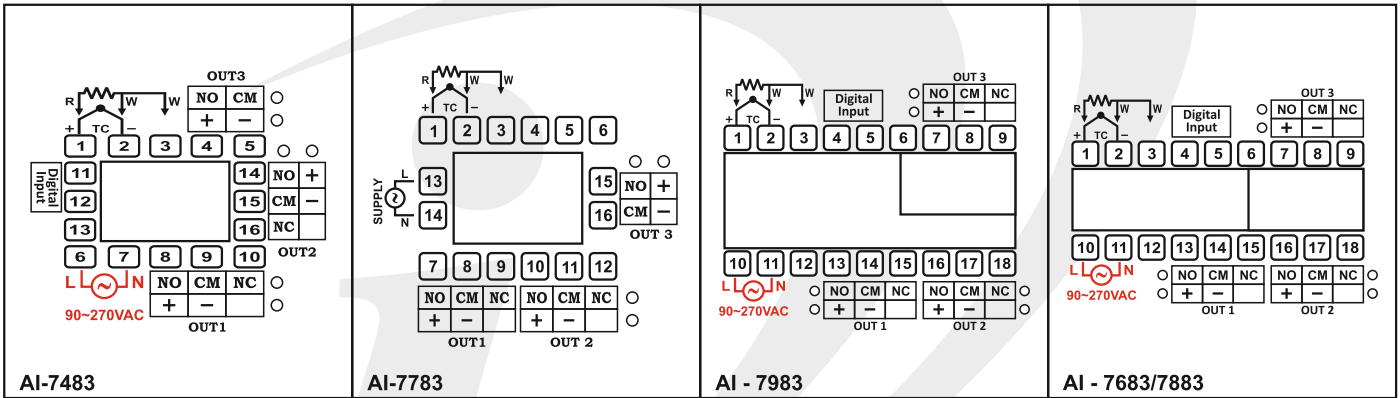



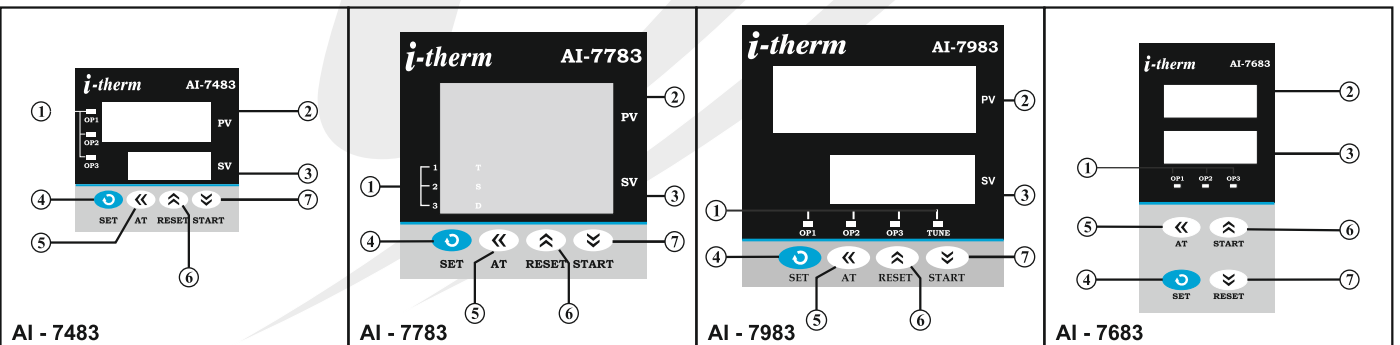

## FRONT PANEL LAYOUT

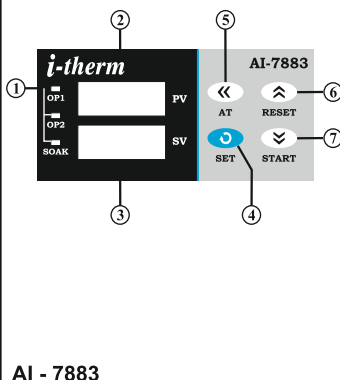

### FRONT PANEL LAYOUT DESCRIPTION :

Sr.	NAME	FUNCTION
1	OP1 LED	Glows when OP1 is ON & flashes when delay time (dly1) is in operation (if selected mode is ON-OFF)
	OP2 LED	Glows when OP2 is ON & flashes when alarm1 condition persists even after acknowledged OR delay time (dly2) is in operation & selected mode is ON-OFF.
	OP3 LED	Glows when OP3 is ON & flashes when alarm2 condition persists even after acknowledged OR delay time (dly3) is in operation & selected mode is ON-OFF.
	T LED	Flashes when instrument tuning mode.
	S LED	Glows when Soak mode is selected & flashes when soak timer is in operation.
	D LED	Glows when Digital Input is open.
2	UPPER DISPLAY	It will display (1) Measured value of selected input or Error messages in run mode. (2) Parameters value in program mode.
3	LOWER DISPLAY	It will display (1) SP (Main set point) / SP2 and SP3 (Auxiliary/Alarm) set value / Set Soak time value/ balance or elapsed soak time in run mode. (2) Parameter code in program mode.









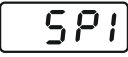
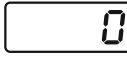

Sr.	NAME	FUNCTION
4	SET KEY 	(1) For SP programming. (2) To access Control mode. (3) To access Configuration mode along with UP key. (4) To scroll the parameter & to store its value.
5	SHIFT KEY 	(1) To increase/alter parameter value in program mode with Up / Dn key. (2) Press for 3sec in programming, this will help to go back to previous parameter.
6	UP KEY 	(1) To increase/alter parameter value in program mode. (2) To enter in configuration mode (with SET key). (3) To acknowledge Alarm. (4) To enter in tune mode (with DOWN key).
7	DOWN KEY 	(1) To decrease/alter parameter value in program mode. (2) To enter in tune mode (with UP key).

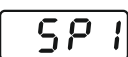
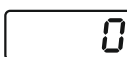
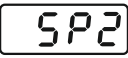
## PROGRAMMING

**RUN MODE :** To access the run mode press **SHIFT** key to change **SP1**.

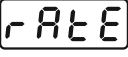
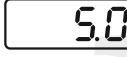
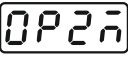
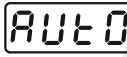
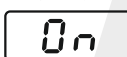
PARAMETER	LOWER DISPLAY	UPPER DISPLAY	RANGE	DESCRIPTION	DEFAULT
CONTROL SET POINT			LSPL ~ HSPL	User can change SP1 value using UP/ DOWN keys. Holding the key, will change the value at a faster rate. Press SET key to store the desired value & move on to the next parameter.	0°C

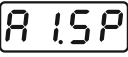
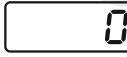
**USER LIST :** To access the user list press **SET** key once.

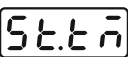
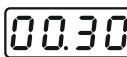
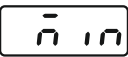
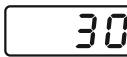
PARAMETER	LOWER DISPLAY	UPPER DISPLAY	RANGE	DESCRIPTION	DEFAULT
CONTROL SET POINT			LSPL ~ HSPL	User can change SP1 value using UP/ DOWN keys. Holding the key, will change the value at a faster rate. Press SET key to store the desired value & move on to the next parameter.	0°C
SET POINT 2			LSPL ~ HSPL -99 to 99 °C	This parameter is prompted if OP2 is configured as AUCn and Sp2 is Enabled (1) Either absolute auxiliary control mode. (2) Either deviation auxiliary control mode.	0°C
SET POINT 3			LSPL ~ HSPL -99 to 99 °C	This parameter is prompted if OP3 is configured as AUCn and SP3 is Enabled (1) Either absolute auxiliary control mode. (2) Either deviation auxiliary control mode.	0°C
RAMP RATE			0.0 °C to 25.0 °C	This parameter will be available only if Enabled in Configuration List. User can set ramp rate/min for SP1 (Set Point) to minimize overshoot.	Disable
OP2 MODE		 ↓ ↑  ↓ ↑ 	-----	This parameter is prompted only if Control Logic for Output1 is configured for Heat-Cool. Output 2 will be automatically activated /de-activated w.r.t SP1 & HYS. Output 2 will be permanently Activated (ON). Output 2 will be permanently De-Activated (OFF).	Auto
ALARM SET POINT			LSPL ~ HSPL -99 to +99 °C 2 to 99 °C	This parameter is prompted if AL.SP is Enable & output 2 is configured as (1) Alarm (High/Low) mode. (2) As a deviation alarm mode. (3) As a band alarm.	0°C
ALARM SET POINT			LSPL ~ HSPL -99 to +99 °C 2 to 99 °C	This parameter is prompted if AL.SP is Enable & output 2 is configured as (1) Alarm (High/Low) mode. (2) As a deviation alarm mode. (3) As a band alarm.	0°C
SOAK TIME			1 Sec to 9999 Hrs.	This parameter is prompted only if output 2 is configured as soak timer. Controller starts the execution of soak time as per the mode selected. Soak timer can be programmed using four different time base in Config. List.	1 min.
MINUTE ELAPSED			-----	This parameter is prompted only if HOUR mode is selected in the Soak timer mode of Op3. (this is a View Only Parameter). During Down Counting of Soak time it will display the remaining time & during up counting of soak time the elapsed time will be displayed.	-----

**CONTROL LIST :** To enter in this mode, press **SET & DOWN** key simultaneously for 3 sec. User can then set the following control parameters.

PARAMETER	LOWER DISPLAY	UPPER DISPLAY	RANGE	DESCRIPTION	DEFAULT
LOCK CODE	LOCK	0	1 ~ 9999	Set this parameter to 15 (Default LOCK CODE) to access Control List. User has a choice to set different Lock Code via USER LOCK CODE in Config. List.	0
PROPORTIONAL BAND	Pb	5.0	0.5 to 99.9°C	This parameter will be prompted only if selected control action is PID. It sets proportional band over which the output power is adjusted depending upon the error (SV-PV). Value of this parameter is automatically set by Auto tune function.	5.0°C
INTEGRAL TIME	Int	240	0 to 3600 Sec.	This parameter will be prompted only if selected control action is PID. It sets the time taken by PID algorithm to remove steady state error. Value of this parameter is automatically set by auto tune function. If set to '0', this function will be disabled.	240
DERIVATIVE TIME	dt	60	0 to 300 Sec.	This parameter will be prompted only if selected control action is PID. It defines how strongly the controller will react to rate of change of PV. Value of this parameter is automatically set by auto tune function. If set to '0', this function will be disabled.	60
CYCLE TIME	CYCL	16.0	1.0 to 100.0 Sec.	This parameter will be prompted only if selected control action is PID. User can set this value based on process being controlled & type of output being selected. For Relay O/P, cycle time should be more than 12sec & for SSR O/P, cycle time should be less than 10sec.	16.0 sec.
OUTPUT POWER LIMIT	OUTL	100.0	0.0 % to 100.0 %	This parameter will be prompted only if selected control action is PID. This parameter will decide the maximum output power in % applied to the load.	100 %
OUTPUT OFF	OP.OF	d56L	1 to 10	This parameter will be prompted only if selected control action is PID. With this parameter O/P will be Completely OFF after the Set Point + Offset Value. If Disable, O/P will act Depending upon the PID Value after Set Point achieved.	Disable
TUNE OFFSET	T.OFS	100	50 % to 100 %	This parameter will be prompted only if selected control action is PID. This parameter allows the User to carry out Auto Tuning function below the set point. (If tune offset is set to 50 %, tuning will be carried out at 50 % of the set point and if set to 100 %, tuning will be carried out at 100 % of the set point.)	100 %
CONTROL HYS	HYS1	2	1 to 25 °C	This parameter will be prompted only if selected control action is ON - OFF. It sets the dead band between ON & OFF switching of the Output. Larger value of hysteresis minimize the number of ON-OFF operation to the load. This increases life of actuators like contactors but, also produces large errors (between PV & SV).	2°C
DELAY 1	dLY1	0	0 to 500 Sec.	This parameter will be prompted only if selected control action is ON - OFF. It sets the main output Delay time where O/P once turned OFF will turn ON only after Delay time, regardless difference between PV & SP. Also, Delay will be considered at every power ON.	0 Sec.
HYS 2	HYS2	2	1 to 99 °C	This parameter will be prompted only if selected control mode for output2 is Auxiliary control or an Alarm. The value of this parameter sets the dead band between ON & OFF switching of output load.	2°C
GAP 1	GAP1	0.0	-9.9 to 9.9°C	This parameter will be prompted only if Control Logic for Output1 is configured for Heat-Cool. SP (set point) will be consider as (SP-Gap1) for heating.	0°C
GAP 2	GAP2	0.0	-9.9 to 9.9°C	This parameter will be prompted only if Control Logic for Output1 is configured for Heat-Cool. SP (set point) will be consider as (SP+Gap2) for cooling.	0°C
DELAY 2	dLY2	0	0 to 500 Sec.	This parameter will be prompted only if Output2 is configured as an Auxiliary control output OR Control Logic is configured for Heat-Cool. In this mode, it sets the output Delay time where O/P once turned OFF will turn ON only after Delay time, regardless difference between PV & SP2. Also, Delay will be considered at every power ON.	0 Sec.
SOAK BAND	HYS3	2	0.0 to 99°C.	This parameter will be prompted only it selected control mode for output2 is auxilliary control or an alarm. The value of this parameter sets the dead band between on and off switching of output load.	2°C



PARAMETER	LOWER DISPLAY	UPPER DISPLAY	RANGE	DESCRIPTION	DEFAULT
SOAK BAND	dl43	0	0 to 500 sec.	This parameter will be prompted only if output 2 is configured as an Auxiliary control output. In this mode, O/P once turned OFF will restart only after set time regardless of the difference between PV and Sp2. Time delay is settable up to 500 seconds. If time delay is set to 0, there is no delay between output switching.	0 Sec.
SOAK BAND	St.bd	0.0	0.0 to 99°C.	This parameter defines the permissible deviation of PV from SP during soak time cycle. If PV falls outside the Soak band during soak cycle, Timer halts. Timer will start only when PV falls within the soak band. This parameter is ignored if set to '0'.	0 Sec.
SOAK TIME DELAY	St.dl	10	0 to 99 Sec.	This parameter will be prompted only if selected control mode for Output2 is Soak timer. Depending on end of soak strategy, the value of this parameter sets the activation time for OP2 when Soak timer is over. Setting this parameter to '0' will make OP2 continuously ON at the end of Soak time till User starts the next cycle.	10 Sec.

- CONFIGURATION LIST :**
- (1) To enter in this mode, press and hold SET & UP key simultaneously for 3 sec.
  - (2) Press UP or DOWN key to scroll between parameter options.
  - (3) Press SET key to store current parameter & move on to the next parameter.

PARAMETER	LOWER DISPLAY	UPPER DISPLAY	DESCRIPTION	DEFAULT																																							
LOCK CODE	LOCK	0	Set this parameter to 15 (Default LOCK CODE) to access Config. List. User have a choice to set different Lock Code via USER LOCK CODE in Config. List.	0																																							
INPUT TYPE	InPt	tc-j	<p>This parameter value is set according to the type of sensor (Thermocouple or RTD input) connected to the controller's input terminals.</p> <table border="1"> <thead> <tr> <th>Sensor Type</th> <th>Range</th> <th>Resolution</th> <th>Accuracy</th> </tr> </thead> <tbody> <tr> <td>Fe-k(J) T/C</td> <td>0 ~ 760°C</td> <td>1 °C</td> <td rowspan="7">} ± 1 °C</td> </tr> <tr> <td>Cr-AL(K) T/C</td> <td>-99 ~ 1300°C</td> <td>1 °C</td> </tr> <tr> <td>(R) T/C</td> <td>0 ~ 1700°C</td> <td>1 °C</td> </tr> <tr> <td>(S) T/C</td> <td>0 ~ 1700°C</td> <td>1 °C</td> </tr> <tr> <td>TC - N</td> <td>-99 ~ 1300°C</td> <td>1 °C</td> </tr> <tr> <td>TC - T</td> <td>-99 ~ 400°C</td> <td>1 °C</td> </tr> </tbody> </table> <p>This parameter value is set according to the type of sensor (Thermocouple or RTD input) connected to the controller's input terminals.</p> <table border="1"> <thead> <tr> <th>Sensor Type</th> <th>Range</th> <th>Resolution</th> <th>Accuracy</th> </tr> </thead> <tbody> <tr> <td>TC - B</td> <td>0 ~ 1800°C</td> <td>1 °C</td> <td>± 1 °C</td> </tr> <tr> <td>Pt-100(RTD)</td> <td>-100 ~ 450°C</td> <td>1 °C</td> <td>± 1 °C</td> </tr> <tr> <td>Pt-100(RTD 0.1)</td> <td>-100.0 ~ 450.0°C</td> <td>0.1 °C</td> <td>± 0.3 °C</td> </tr> </tbody> </table>	Sensor Type	Range	Resolution	Accuracy	Fe-k(J) T/C	0 ~ 760°C	1 °C	} ± 1 °C	Cr-AL(K) T/C	-99 ~ 1300°C	1 °C	(R) T/C	0 ~ 1700°C	1 °C	(S) T/C	0 ~ 1700°C	1 °C	TC - N	-99 ~ 1300°C	1 °C	TC - T	-99 ~ 400°C	1 °C	Sensor Type	Range	Resolution	Accuracy	TC - B	0 ~ 1800°C	1 °C	± 1 °C	Pt-100(RTD)	-100 ~ 450°C	1 °C	± 1 °C	Pt-100(RTD 0.1)	-100.0 ~ 450.0°C	0.1 °C	± 0.3 °C	TC - J
Sensor Type	Range	Resolution	Accuracy																																								
Fe-k(J) T/C	0 ~ 760°C	1 °C	} ± 1 °C																																								
Cr-AL(K) T/C	-99 ~ 1300°C	1 °C																																									
(R) T/C	0 ~ 1700°C	1 °C																																									
(S) T/C	0 ~ 1700°C	1 °C																																									
TC - N	-99 ~ 1300°C	1 °C																																									
TC - T	-99 ~ 400°C	1 °C																																									
Sensor Type	Range	Resolution		Accuracy																																							
TC - B	0 ~ 1800°C	1 °C	± 1 °C																																								
Pt-100(RTD)	-100 ~ 450°C	1 °C	± 1 °C																																								
Pt-100(RTD 0.1)	-100.0 ~ 450.0°C	0.1 °C	± 0.3 °C																																								
LOWER SET POINT LIMIT	LSPL	0	Sets the minimum limit for set point adjustment. It can be set from minimum specified range of selected sensor to HSPL value.	0°C																																							
HIGHER SET POINT LIMIT	HSPL	400	Sets the maximum limit for set point adjustment. It can be set from LSPL value to maximum specified range of selected sensor.	400°C																																							
PROCESS VALUE OFFSET	OFSt	0	Function of this parameter is to add/subtract a constant value to the measured PV to obtain Final PV for control applications. This parameter value needs to be altered for one of the following reason : - (i) To compensate for known thermal gradient. (ii) To match the display values with another recorder or indicator measuring the same PV.	0°C																																							

PARAMETER	LOWER DISPLAY	UPPER DISPLAY	DESCRIPTION	DEFAULT
INPUT FILTER	FLtr	6	The controller is equipped with an adaptive digital filter which is used to filter out any extraneous pulses on the PV. The filtered PV Value is used for all PV dependent functions. If the PV signal is fluctuating due to noise, increase the filter time constant value.	6
CONTROL MODE FOR O/P 1	node	PId ↓ ↑ OnOF	User can select between PID or ON-OFF action algorithm to be adopted for output.	PID
CONTROL LOGIC FOR O/P 1	OP1L	HEAt	User can select heating logic in which OP1 will remain ON till PV < SP. (PV increases when output is ON.)	Heat
		COOL	User can select cooling logic in which OP1 will remain ON till PV > SP. (PV decreases when output is ON.)	
		HECL	This parameter will be prompted only if selected input is RTD or RTD.1 and is used for BOD application. Here OP1 acts as Heating control & OP2 as Cooling control.	
CONTROL TIME FOR O/P 1	OP1t	RLY	User has to set this parameter very carefully in accordance with the output used. (Separate terminals for RELAY & SSR:- Refer Electrical Installation) Select Relay if LOAD is connected via contactor. Whenever user selects Relay, Cycle time will automatically set to 16 sec. User can modify cycle time via control list.	Relay
		SSr	Select SSR if LOAD is connected via SSR (DC voltage pulses). Whenever user selects SSR, cycle time will automatically set to 1 sec. User can modify cycle time via Control List.	
OVER SHOOT CONTROL POINT	OCP	dSbL	This parameter will be prompted only if selected control action is PID. Setting this parameter on higher side will proportionally slows down the rate of rise of PV to minimize overshoot (this may cause delay to reach SP). Setting on lower side will proportionally or disabling this parameter will increase the rate of rise of PV (which may cause overshoot). Disable this option if delay is not required to reach SP.	Disable
RAMP RATE	rAtE	EnbL	This parameter will be prompted only if OCP (over shoot control point) is disabled. When enabled, User can set the desired RAMP rate in USER list.	Disable
		dSbL	When disabled, this parameter will not be prompted in USER list.	
AUTO TUNE	tunE	EnbL	This parameter will be prompted only if selected control action is PID. If Enabled, this parameter will be prompted if user press Up & Down keys Simultaneously for 3Sec.	Enable
		dSbL	If Disabled, this parameter will not be prompted if user press Up & Down keys Simultaneously for 3Sec.	
SET POINT 1	SP1	EnbL	If Enabled, User can View & edit the Set point (SP1) in USER list.	Enable
		dSbL	If disabled, User can only View the Set Point (SP1) but Can not edit it in USER list.	
OUTPUT 2 MODE	OP2n	EnbL	This parameter will appear only if Control logic is Heat-Cool. If Enabled, User can set Diff. mode for OUTPUT 2 in USER list.	Disable
		dSbL	If disabled, User can not set Diff. mode for OUTPUT 2 in USER list.	
OUTPUT 2 CONTROL	OP2C	15.0	This parameter will appear only if Control logic is Heat-Cool. OP2 will be OFF at Ambient + OP2C value irrespective of output 2 mode.	15.0
OUTPUT 2 FUNCTION	OP2	nOnE	When NONE is selected, Output 2 will be permanently de-activated.	Auxiliary
		AUCn	This parameter allows the user to select output 2 as an 'Auxiliary' control. For options refer Table 3.	
		ALrñ	This parameter allows the user to select output 2 as an 'Alarm' control. For options refer Table 4.	

PARAMETER	LOWER DISPLAY	UPPER DISPLAY	DESCRIPTION	DEFAULT
OUTPUT 2 FUNCTION	OP3	nOnE	When NONE is selected, Output 3 will be permanently de-activated.	Auxiliary
		↓ ↑ AUCn	This parameter allows the user to select output 3 as an 'Auxiliary' control. For options refer Table 3.	
		↓ ↑ ALrñ	This parameter allows the user to select output 3 as an 'Alarm' control. For options refer Table 4.	
		↓ ↑ SOAK	This parameter allows the user to select output 3 as a 'Soak' mode. For options refer Table 5.	
		↓ ↑ ALSt	This parameter allows the user to select output 3 to function as both 'Alarm' & 'Soak'. For options refer Table 4 & 5.	
LOWER DISPLAY MESSAGE	LdSP	tOGL	By pressing DOWN key, Lower display will Toggle between SP1-value, SP2-value, Alarm SP-Value(AL.SP) & Timer-value(SOAK).	SP1
		↓ ↑ SP1	By this parameter Lower display will only show the SP1-value.	
		↓ ↑ tñEr	By this parameter Lower display will only show the Timer value(SOAK TIME).	
USER LOCK CODE	ULOC	15	Default USER LOCK CODE is 15 to access Control & Configuration List. User has a choice to set its own USER LOCK CODE between 1 to 9999, this is to prevent unauthorized access of Control & Configuration List.	15

**TABLE 3 : Below listed options will appear only if OP2 is selected as an Auxiliary Control Mode .**

PARAMETER	LOWER DISPLAY	UPPER DISPLAY	DESCRIPTION	DEFAULT
SET POINT 2	SP2	AbS	If selected, User can set SP2 value independently, irrespective of SP1.	ABS
		↓ ↑ SP3	In this mode SP2 is always related with SP1. User can set SP2 value with deviation of $\pm 99^{\circ}\text{C}$ w.r.t SP1.	
OUTPUT 2 LOGIC	OP2L	HEAT	User can select Heat logic for control Output 2 in which OP2 will remain ON till $PV < SP2$ (PV increases when output is ON).	HEAT
		↓ ↑ OP3L	User can select Cool logic for control Output 2 in which OP2 will remain ON till $PV > SP2$ (PV decreases when output is ON).	
SET POINT 2	SP2	EnbL	If Enabled, User can View & edit the Set point (SP2) in USER list.	Enable
		↓ ↑ SP3	If disabled, User can not View or edit Set Point (SP2) in USER list.	

**TABLE 4 : Below listed points will appear only if O/P2 is selected as an Alarm mode. In Alarm mode, Controller continuously compares PV with either SP (for deviation or Band -alarm) or an independent Alarm set points (for process high and process low alarm). HYS2 in Control list decides when to switch OFF the Alarm.**

PARAMETER	LOWER DISPLAY	UPPER DISPLAY	DESCRIPTION	DEFAULT
ALARM TYPE	ALTY	LOY	<p><b>Direct acting</b></p> <p>Low Alarm : OP2 activates when <math>PV &lt; SP2</math>.</p>	Low
		HIGH	<p><b>Reverse acting</b></p> <p>High Alarm : OP2 activates when <math>PV &gt; SP2</math>.</p>	
		Lodu	<p><b>Low Deviation Alarm</b> : OP2 activates when PV is less than <math>SP1 \pm</math> set deviation value</p>	
		Hi.du	<p><b>High Deviation Alarm</b> : OP2 activates when PV is greater than <math>SP1 \pm</math> set deviation value</p>	
		band	<p><b>Band Alarm</b> : OP2 activates when PV falls outside the band w.r.t. <math>SP1</math> in either direction.</p>	
		<p>ALARM LOGIC</p> <p>A1LG</p> <p>A2LG</p>	<p>dir</p> <p>rev</p>	
<p>ALARM INHIBIT</p> <p>A1IH</p> <p>A2IH</p>	<p>YES</p> <p>NO</p>	<p>If this parameter is set as 'YES' &amp; Alarm condition persists, it will Disable Alarm O/P at power ON.</p> <p>If this parameter is set as 'NO' &amp; Alarm condition persists, it will Enable Alarm O/P at power up.</p>	No	
<p>ALARM ACK.</p> <p>A1AP</p> <p>A2AP</p>	<p>AUTO</p> <p>MANUAL</p> <p>BOTH</p>	<p>Once the Alarm is activated, User has following three options to de-activate it. When PV falls within the programmed limits The Alarm will be de-activated automatically.</p> <p>Once the alarm is activated, it remains activated until acknowledged manually by UP key.</p> <p>Once the alarm is activated, it can be de-activated either by pressing UP key or when PV falls within the alarm limits.</p>	Auto	
<p>ALARM SET POINT</p> <p>A1SP</p> <p>A2SP</p>	<p>ENBL</p> <p>DSBL</p>	<p>If Enabled, User can View &amp; edit the Alarm Set point in USER list.</p> <p>If disabled, User can not View or edit Alarm Set Point in USER list.</p>	Enable	



**TABLE 5 : Below listed option will appear only if OP2 is selected as a soak timer.**

PARAMETER	LOWER DISPLAY	UPPER DISPLAY	DESCRIPTION	DEFAULT
END OF SOAK STRATEGY	SP.E5	none	It defines the behaviour of the controller at the end of soak timer cycle . Options are as below. If selected, the controller maintain PV at SP indefinitely irrespective of start or end of a soak timer.	BOTH
		H.OFF	The controller de-energizes OP1 as soon as the soak time is over. Here upper display will continue to show PV & lower display will show message "start".Next cycle will start only when user press START key for 3 sec.	
		ALOn	The controller energizes OP2 for a time period programmed via (StdL) parameter at the end of a soak time cycle. User can utilise OP2 for audio/visual indication.	
		both	The controller executes both, the Heater OFF and Alarm ON function as described above.	
TIME BASE SOAK TIMER	SP.tb	nn.ss	User can select the timer base of soak time among the four options as shown. Minutes & Seconds (Range 99 minutes, 59 seconds).	MMMM
		nnnn	Minutes (Range 9999 minutes).	
		HH.nn	Hours & Minutes (Range 99 Hours , 59 minutes).	
		HHHH	Hours (Range 9999 Hours).	
DIRECTION FOR SOAK TIME	St.dr	UP	If selected, soak timer will increment (from 0 to set value) (Note:- User can alter the new time value which should be > elapsed time even if soak timer is running. If user sets new time value < elapsed time, running timer will be terminated & End of soak Strategy will be executed.	DN
		dn	If selected ,soak timer will decrement (from set value to 0). (Note:- User can alter the new time value even when soak timer is running. In this case, balance time of previous set value will be ignored & new cycle will be executed.	
RESET OF RUNNING SOAK TIME	SP.r5	YES	If set as 'YES', soak time value will not be stored at the time of power failure.	NO
		no	If set as 'NO' at power ON, soak time will continue from stored value. (Note: Seconds will not be stored.)	
TIMER START MODE	SP.nd	nod1	User can define 4 different modes to start the soak timer as follows : - In this mode, Timer will start after pressing START key for 3 sec., irrespective of PV.	MOD 2
		nod2	In this Mode, after power ON Timer starts when PV >= SV. To continue with next cycle, user has to either switch Power on & off <b>OR</b> press START key for 3 sec when STRT message is displayed on the lower display.	
		nod3	In this Mode, Timer will start only after pressing START key for 3 sec & PV>=SV for any of the following conditions. (1) At every Power ON. (2) Completion of current soak time cycle. (3) Power failure during soak time is in progress.	
		nod4	In this Mode, Timer will start only after pressing START key for 3 sec & PV>=SV for any of the following conditions. (1) At every Power ON. (2) Completion of current soak time cycle. After executing start command, if cycle doesn't complete due to power failure, cycle will continue whenever PV >= SV after restore of power. <b>No need to press START key.</b>	

**Note : - 1) User can restart soak time at any moment during its execution, by pressing START key for 3 sec.**

**AUTO TUNING MODE** : To enter in this mode, Press and hold SHIFT key for minimum 3 sec.

PARAMETER	LOWER DISPLAY	UPPER DISPLAY	DESCRIPTION	DEFAULT
AUTO TUNING MODE	At	n0 v ^ YES	This function will be executed only if selected control action is PID & Auto tune is Enable. The Auto-tuning function can be initiated by setting this parameter to YES. The decimal of LSB flashes till auto tuning function is in progress. During Auto-tuning, The controller learns the process characteristics by itself & calculates required P, I & D values. User can cancel or abort this feature by setting this parameter to NO.	NO



**Mfgd by: Innovative Instruments & Controls LLP**

Unit no 101- 105, Patel Industrial Estate, Building No.5, Near Range office,  
Gaurapada, Vasai East, Palghar, Maharashtra 401208.

Sales : +91-8591939916 / 17 / +91-8655832205

Support : +91-7208897610

E-mail : [sales@itherm.co.in](mailto:sales@itherm.co.in)

Website : [www.itherm.co.in](http://www.itherm.co.in)

